

# Data Sheet



Article number: 02150000074

Description: Sealing Clamp S 74 W1

## Measures

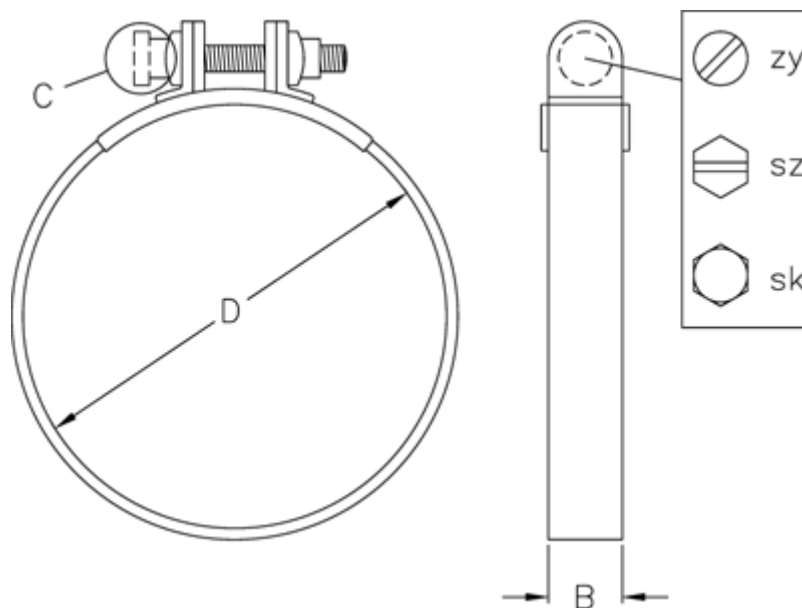

C (screw type) = SZ

Diameter D = 74

Width B = 20